

1. Main

Main

Exploded View

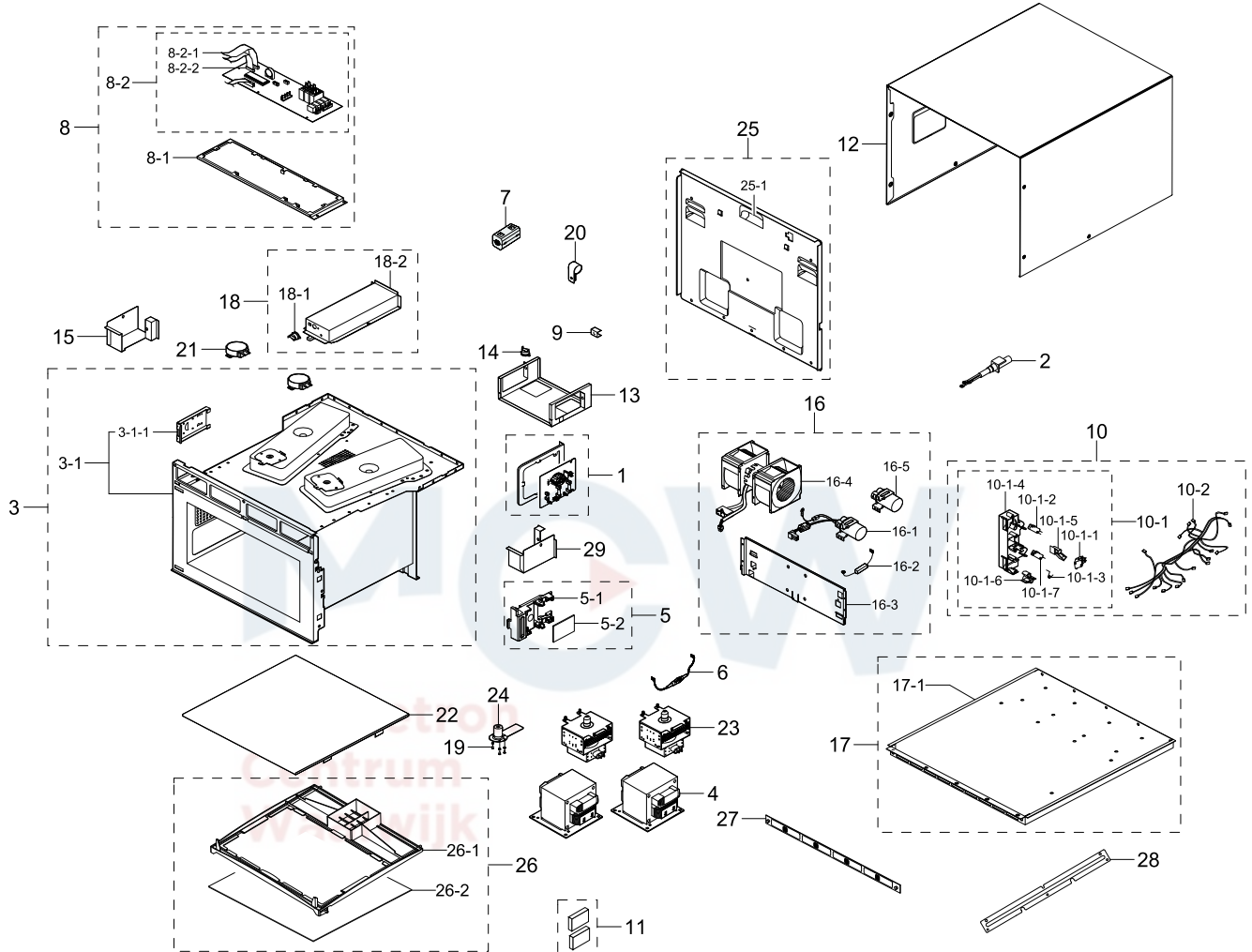

Parts List

No.	Lvl.	Loc.	Material Code	Description & Specification	SNA	Qty.
1	2	M017	DE96-00734A	ASSY NOISE FILTER; SN-CM1929,250V/15A,250	SA	1
2	2	M015	DE96-00180B	POWER CORD-AT; H07RN-F 3x1.5mm2,BLK,GB3F,	SA	1
3	2	Z782	DE92-10157C	ASSY CAVITY; MJ6000A,2.6Cu.ft,STS430	SNA	1
3-1	3		DE94-05029A	ASSY CAVITY MAIN; MJ26A6091AT,26L,STS430,	SNA	1
3-1-1	4		DE61-01764A	BRACKET LAMP; MJ6000A_HEAVY CMM,GI-SGCC,T	SA	1
4	2	M038	DE26-00058B	TRANS H.V; SHV-906EG2,240V,2400V/3.40V,AL	SA	2
5	2		DE94-05168A	ASSY HOLDER LAMP; MJ26A6091AT/EU	SNA	1

Exploded Views and Parts List

No.	Lvl.	Loc.	Material Code	Description & Specification	SNA	Qty.
5-1	3		DE61-01765A	HOLDER LAMP; MJ6000A_HEAVY CMM,PP,natural	SA	1
5-2	3		DE96-01131A	ASSY LAMP LED; 2ea,METAL,30*20,WHITE,2003	SA	1
6	2	M042	DE91-70061A	ASSY H.V.FUSE; THV060T,5KV,800,SCREW,WHT,	SA	2
7	2	M052	DE73-90027A	CORE-FERRITE; T13.8,NI-ZN,BNF-14(K150),L2	SNA	2
8	2	C238	DE94-04979B	ASSY BRACKET PANEL; MJ26A6091AT/EU,EGI-SE	SA	1
8-1	3	R066	DE61-50520A	BRACKET PCB; EGI-SECC,T0.8,CM-1819	SA	1
8-2	3	F316	DE92-04508A	ASSY PCB MAIN; Main,MJ6000A,230V/50Hz,EUP	SA	1
8-2-1	4	W001	DE39-40692A	ASSY WIRE HARNESS-SUB; CM1819/29,230VAC,I	SA	1
8-2-2	4	C033	DE39-40694A	ASSY WIRE HARNESS-SUB; CM1929,230VAC,IEC,	SA	1
9	2	M011	DE61-50541A	BRACKET EARTH; EGI-SECC,T1,W15,L8	SNA	1
10	2		DE94-03465S	ASSY HOLDER-WIRE; NEW COMMERCIAL,DE96-005	SNA	1
10-1	3	B022	DE93-20097E	ASSY BODY LATCH; CM1819/1829,EUROPE	SA	1
10-1-1	4	S0021	3405-001055	SWITCH-MICRO; 125/250VAC,16A,200gf,SPST-N	SC	2
10-1-2	4	B048	3405-001034	SWITCH-MICRO; 125/250VAC,16A,200gf,SPST-N	SA	1
10-1-3	4	B005	DE61-00066A	SPRING-Q; CM1819/1829,MSWR-SWRM,PI0.8	SNA	1
10-1-4	4	B077	DE66-40062A	LATCH BODY; CM-1819,PBT,NATURAL,NATURAL	SA	1
10-1-5	4	B012	DE66-90107A	LEVER SWITCH; PBT,VB-5050G,NATURAL,NATURA	SA	1
10-1-6	4	B013	DE66-90108A	LEVER SWITCH; PBT,VB-5050G,NATURAL,NATURA	SA	1
10-1-7	4	B046	3405-001032	SWITCH-MICRO; 125/250VAC,16A,200gf,SPDT,T	SA	2
10-2	3		DE96-00503C	ASSY WIRE HARNESS-MAIN; MM26A6093AT/EU,23	SA	1
11	2	M056	DE63-90062C	CUSHION-HVT; NEOPRENE RUBBER,T18,W30,L50	SA	2
12	2	M001	DE70-30123C	PANEL OUTER; MM26A6091AT,STS430J1L,T0.6,W	SA	1
13	2	P046	DE72-50088A	DUCT FAN; CM-1819,ALCOT,T0.5	SA	1
14	2	M029	DE47-20017A	THERMOSTAT; AC125/250V,15/10A,150C,60C,No	SA	1
15	2	P047	DE72-50090A	DUCT-MGT/L; CM-1819,EGI-SECC,T0.5	SA	1
16	2	M020	DE96-01135A	ASSY MOTOR FAN; MJ26A6091AT/EU,1.10uF/1.0	SNA	1
16-1	3	M039	2501-001284	C-OIL HIGH VOLTAGE; 1100nF,2100V,BK,34x54	SA	1

No.	Lvl.	Loc.	Material Code	Description & Specification	SNA	Qty.
16-2	3	M527	DE59-00002A	DIODE-H.V; MWO,2CL4512H/CL04-12A,500mA,12	SA	2
16-3	3	M112	DE61-30189A	SUPPORT-FAN-MOUNT; EGI-SECC,T1,CM-1819	SA	1
16-4	3	M024	DE31-10180A	MOTOR AC VENTILATION; SMV-1829EA,2Pole,22	SNA	1
16-5	3	M039	2501-001283	C-OIL HIGH VOLTAGE; 1050nF,2100V,BK,34x54	SNA	1
17	2	M155	DE93-10106F	ASSY BASE PLATE; CM1029/XEU,COATING	SNA	1
17-1	3	M155	DE93-10106C	ASSY BASE PLATE; CM1819,SECC,-,-	SA	1
18	2		DE92-90519B	ASSY DUCT AIR; CM1929B,COMMERCIAL,STSS430	SA	1
18-1	3	M440	DE47-20008A	THERMOSTAT; AC125/250V,15/10A,100C,60C,No	SA	1
18-2	3		DE72-50091B	DUCT AIR; CM1929B,COMMERCIAL,STS430,T0.4	SNA	1
19	2	M078	DE69-90054A	CLIP-STIRRER; 5mm,TEFLON-PFA,CM1819/29	SA	6
20	2	M058	6502-001056	CABLE CLAMP; DAWH-2NC,ID18.5,NYLON6/6,NTR	SNA	3
21	2	M049	DE31-10164B	MOTOR AC DRIVE; M2CK34A709-H(B),8,120V,60	SA	2
22	2	T002	DE97-00319B	ASSY-TRAY CERAMIC; CM1929A/XEU,MWO-COMMER	SA	1
23	2	M035	OM75P-20-ESRN	MGT; MGT		2
24	2	P001	DE92-90515A	ASSY STIRRER; CM-1819/CM-1829,-	SA	2
25	2	P074	DE92-90514A	ASSY-BACK COVER; CM-1819,-,CM-1829,	SA	1
25-1	3	P026	DE72-50087A	DUCT-EXHAUST; ALCOAT-SA1C,T0.6	SA	3
26	2	C165	DE97-00562A	ASSY COVER PANEL; CM1019,PP+SGL,-,-	SA	1
26-1	3	M087	DE63-00315A	COVER STIRRER; CM1019,PP+TD30%,NATURAL,TB	SA	1
26-2	3	M051	DE63-00324A	COVER-CEILING; CM1019,MICA SHEET,T1,W234,	SA	1
27	2	M425	DE92-90516B	ASSY BRACKET FILTER; CM1819,-,-,-	SA	1
28	2	P073	DE61-50538A	BRACKET-PLATE; EGI-SECC,T1	SA	1
29	2	P048	DE72-50089A	DUCT-MGT/R; CM-1819,EGI-SECC,T0.5	SA	1

2. Assy Door

Assy Door

Exploded View

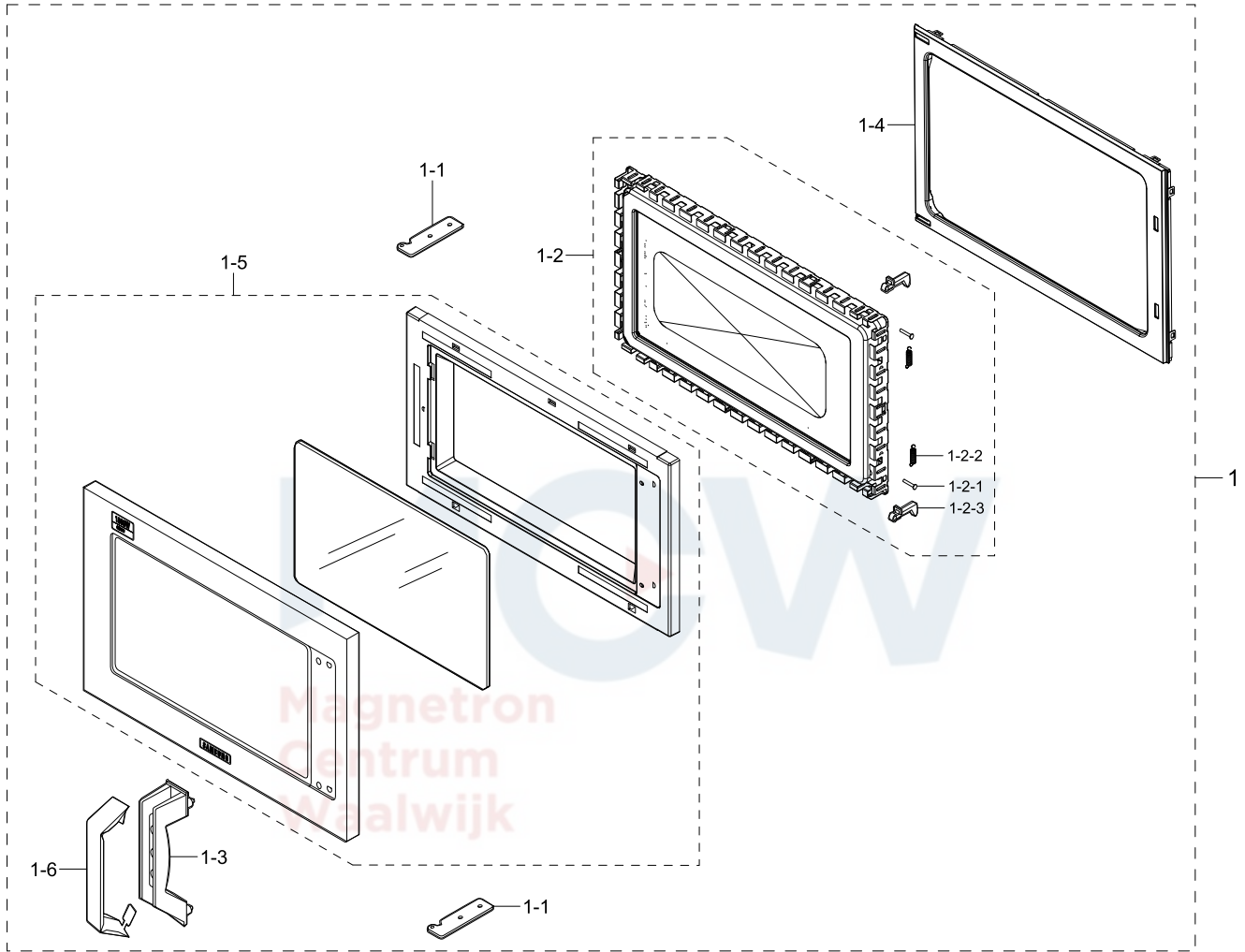

Parts List

No.	Lvl.	Loc.	Material Code	Description & Specification	SNA	Qty.
1	1		DE94-05010A	ASSY DOOR-MODULE; MM26A6091AT, MM26A6093A	SA	1
1-1	2	D008	DE61-80138A	HINGE; EGI-SECC,T3,W24.5,L29.5	SA	2
1-2	2	D004	DE94-05008A	ASSY DOOR E; MM26A6091AT, MM26A6093AT,ABS	SNA	1
1-2-1	3	D018	DE60-60080A	PIN-KEY; STS304,L23	SA	2
1-2-2	3	D007	DE61-70144A	SPRING-KEY; HSWR-SWRH,PI1.0,OD6.5,L32.8,2	SA	2
1-2-3	3	D011	DE64-40296B	DOOR-KEY; CMO COMMERCIAL,CR3C + ZINC DIEC	SA	2
1-3	2	D019	DE64-20123A	HANDLE; CM-1819,ZN,-,-,-,CM-1819,-	SNA	1

No.	Lvl.	Loc.	Material Code	Description & Specification	SNA	Qty.
1-4	2		DE64-03093A	DOOR C; CM1919/XEU,PP+GF30%,T1.5,W456,L26	SA	1
1-5	2	D037	DE94-05009A	ASSY DOOR A; MM26A6091AT, MM26A6093AT,ABS	SNA	1
1-6	2	D147	DE71-60433B	COVER HANDLE; CM1929A,STS430J1L,T0.5	SA	1



3. Assy Control Box

Assy Control Box

Exploded View

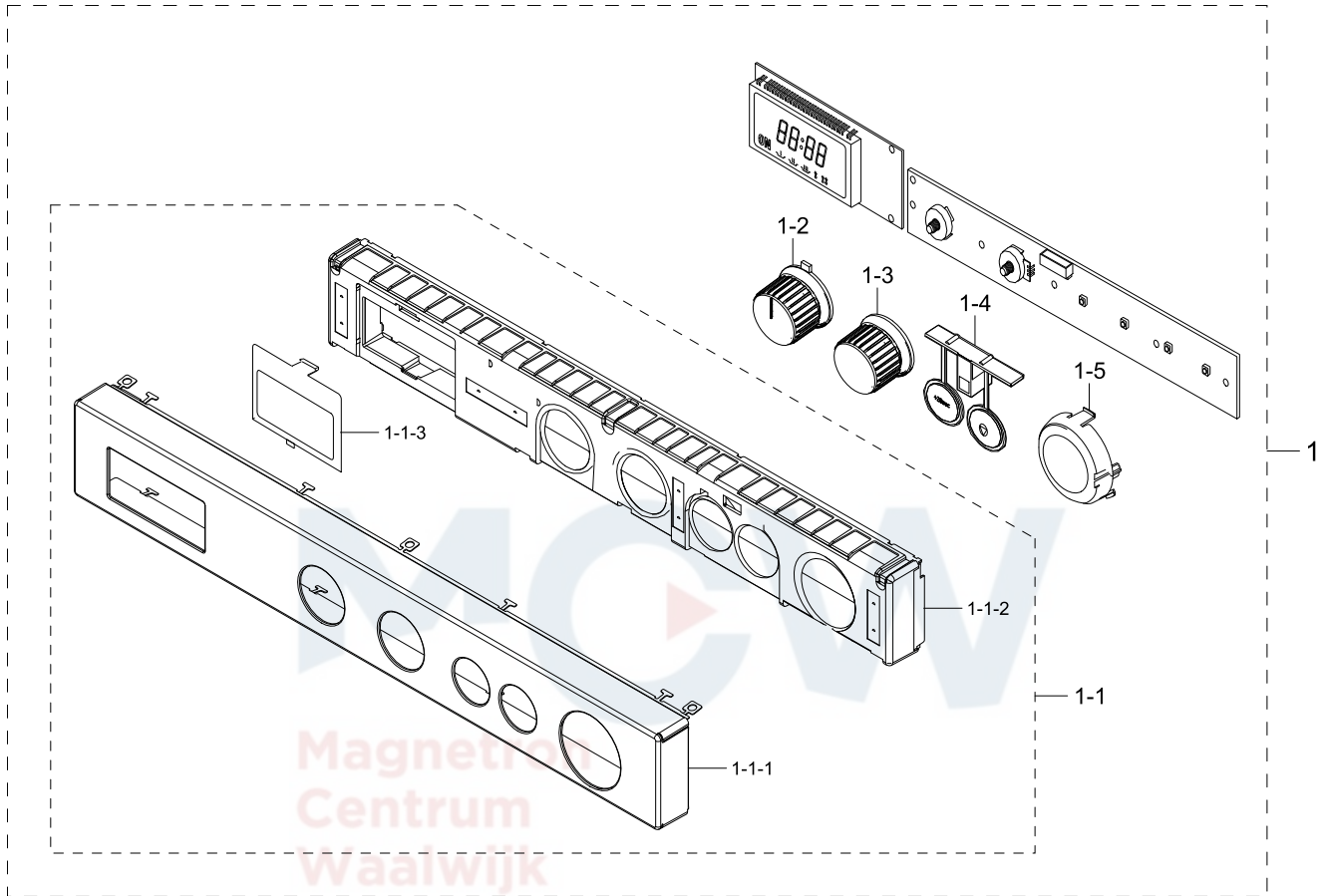

Parts List

No.	Lvl.	Loc.	Material Code	Description & Specification	SNA	Qty.
1	1		DE94-05003A	ASSY CONTROL BOX-MODULE; MM26A6091AT,STSS	SNA	1
1-1	2	C001	DE94-05004A	ASSY CONTROL PANEL; MM26A6091AT,STSS,ABS	SA	1
1-1-1	3		DE64-03094A	CHASSIS PANEL; MJ6000A,STS430J1L,T0.5,W46	SNA	1
1-1-2	3		DE64-03096A	PANEL CONTROL; MJ6000A,ABS,W462.8,L64.8,H	SNA	1
1-1-3	3	C009	DE67-40161B	WINDOW-DISPLAY; CM1929,SAN,CR-5381,BLACK	SA	1
1-2	2		DE64-03095A	KNOB SELECT; MJ6000A,ABS,HB,GE BLACK,NEO	SA	1
1-3	2		DE64-03098A	KNOB TIMER; MJ6000A,ABS,HB,GE BLACK,NEO S	SA	1

No.	Lvl.	Loc.	Material Code	Description & Specification	SNA	Qty.
1-4	2		DE64-03097A	BUTTON SELECT; MJ6000A,ABS,HB,GE BLACK,NE	SA	1
1-5	2		DE64-03099A	BUTTON START; MJ6000A,ABS,HB,GE BLACK,NEO	SA	1

